

TV-Free **Universal video-in-motion Interface**

TF-U500

Non plug & play version for high speed CAN

Legal Information

By law, watching moving pictures while driving is prohibited, the driver must not be distracted. We do not accept any liability for material damage or personal injury resulting, directly or indirectly, from installation or operation of this product. This product should only be used while standing or to display fixed menus or rear-view-camera video when the vehicle is moving, for example the MP3 menu for DVD upgrades.

Changes/updates of the vehicle's software can cause malfunctions of the interface. We offer free software-updates for our interfaces for one year after purchase. To receive a free update, the interface must be sent in at own cost. Labor cost for and other expenses involved with the software-updates will not be refunded.

Contents

1. Prior to installation

- 1.1. Delivery contents
- 1.2. Pin-assignments
- 1.3. DIP switch functions of the TV-500

2. Installation

3. Specifications

4. Technical support

1. Prior to installation

Read the manual prior to installation. Technical knowledge is necessary for installation. The place of installation must be free of moisture and away from heat sources.

1.1. Delivery contents

Take down the SW-version and HW-version of the interface-boxes, and store this manual for support purposes!

CAN-box TV-500
HW _____ SW _____

Harness
TV-UNI

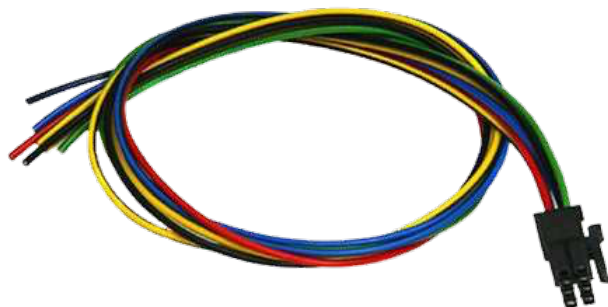

With USB update-port for software-updates by consumer!

1.2. Pin-assignments

Pin-assignment harness TV-UNI

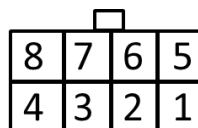

Pin-assignment male 8pin connector of TV-500

Cable colour	Pin-No.	Assignment
● Yellow	Pin 4	CAN-HIGH – connection to the head-unit
● Blue	Pin 3	CAN-LOW – connection to the head-unit
●● Yellow/Black	Pin 8	CAN-HIGH – connection to the vehicle
●● Blue/Black	Pin 7	CAN-LOW – connection to the vehicle
● Red	Pin 1	+12V permanent
● Black	Pin 5	Ground
● Green	Pin 6	Activation of the video-in-motion function (+12V = TV-free activated)
● White	Pin 2	Trigger output (+12V DC 500mA)

1.3. DIP switch functions of the TV-500

DIP 1 – activation TV-free

DIP 2 – no function (in some vehicles for rear-view camera)

DIP 3 – no function

DIP 4 – no function

DIP 5 – CAN-bus termination resistor on the vehicle side

DIP 6 – CAN-bus termination resistor on the head-unit side

2. Installation

Switch off ignition and disconnect the vehicle's battery! If according to factory rules disconnecting the battery has to be avoided, it is usually sufficient to put the vehicle in sleep-mode. In case the sleep-mode does not show success, disconnect the battery with a resistor lead.

Install the interface at the CAN bus connection of the respective navigation system. Separate the two CAN BUS cables (CAN-HIGH and CAN-LOW) from the navigation system and connect them to harness TV-UNI (see picture below).

Connect the **red wire** to **+12V permanent** and connect the **black wire** to **ground**.

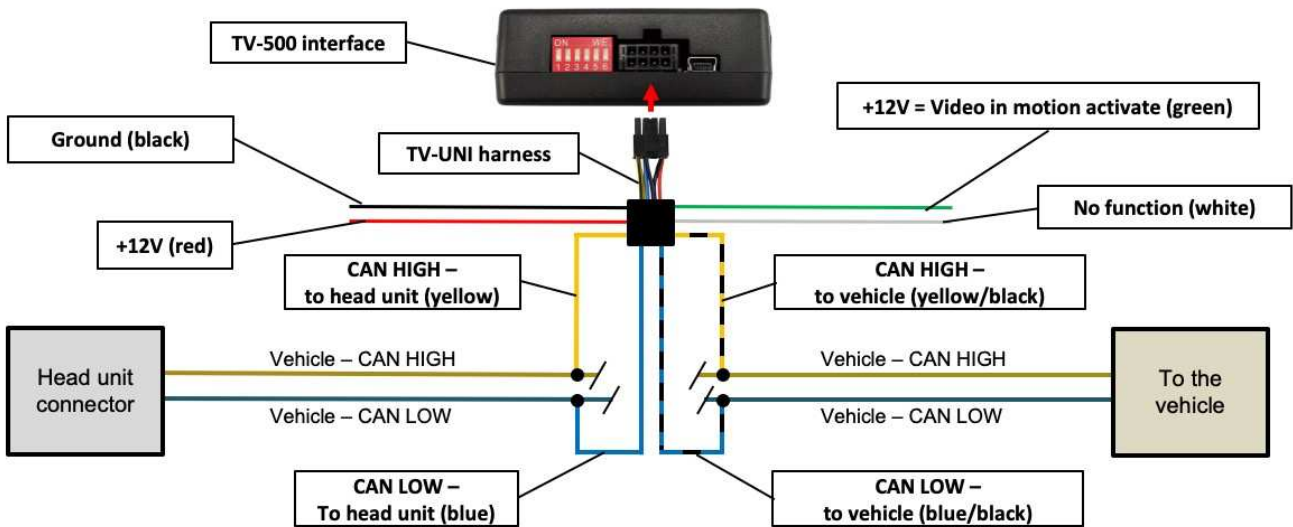

The video-in-motion can be activated and deactivated by DIP 1 or alternatively by the included loose green cable in connection with a switch (not included in delivery).*

Video-in-motion permanent

With DIP1 to ON the video-in-motion function is activated permanently without disturbing the navigation performance.

Video-in-motion selective

With DIP1 to OFF the included green cable is used to activate the video-in-motion function.

Connect a switch to the green cable and connect the green cable to +12V ACC.

- +12V = TV-Free is activated
- 0V = TV-Free is not activated

Note: The loose white cable is not required and must be isolated.

***Exception: On vehicles/navigation systems with DIP 1 must be set to OFF and video-in-motion activation performs selectively by vehicle button, the activation by green cable isn't possible!**

Vehicles with Audi Navi Plus RNS-E



Place of installation is at the back side of the navigation unit.

Compatible vehicles Audi A3, A4, TT (8J)

Attention! Audi A6 with Navi Plus RNS-E have analog speed signal.

Vehicle/ navigation	DIP 1	DIP 2	DIP 3	DIP 4	DIP 5	DIP 6
Navi Plus RNS-E	OFF	OFF	OFF	OFF	OFF	OFF

Cable colour	Assignment
● Red/Yellow	+12Volt Permanent 15
● Brown	Ground Pin 12
● Orange/Green	CAN HIGH Pin 9
● Orange/Brown	CAN LOW Pin 10

**No liability for vehicle wire colors and pin definition!
Possible changes by the vehicle manufacturer. The given information must be verified by the installer.**

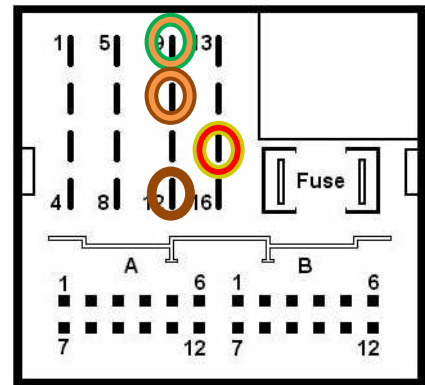

Longpress the „>|“ button (about 5 seconds) to activate/deactivate the video-in-motion function. When ignition is off, the video-in-motion interface will be automatically disabled.



Long blinking of the navigations backlight = TV Free ON
Short blinking of the navigations backlight = TV Free OFF

Note: *While the video-in-motion function is activated, the navigation performance is not possible!*

Vehicles with Audi Navigation plus with MMI touch



Place of installation is at the back side of the navigation unit

<i>Compatible vehicles</i>	Audi
<i>Navigation</i>	Navigation plus with MMI touch 7"

Vehicle/navigation	DIP 1	DIP 2	DIP 3	DIP 4	DIP 5	DIP 6
MMI - MIB	ON	OFF	OFF	OFF	ON	ON

Cable colour	Assignment
● Red	+12V permanent Pin 18
● Brown	Ground Pin 17
● Orange/Violet	CAN HIGH Pin 6
● Orange/Brown	CAN LOW Pin 12

**No liability for vehicle wire colors and pin definition!
Possible changes by the vehicle manufacturer. The given
information must be verified by the installer.**

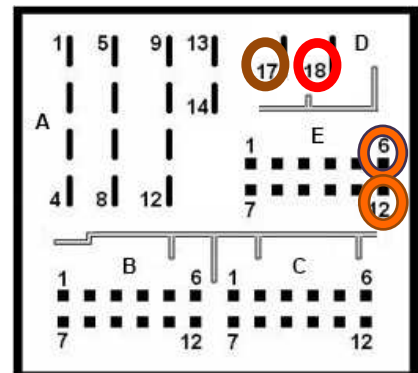

The video-in-motion function is activated permanently without disturbing the navigation performance.

Vehicles with Audi Navigation plus with MMI touch response



Place of installation is at the back side of the navigation unit

<i>Compatible vehicles</i>	Audi
<i>Navigation</i>	MMI Navigation plus with MMI touch response 10,1"

Vehicle/navigation	DIP 1	DIP 2	DIP 3	DIP 4	DIP 5	DIP 6
MMI - MIB	ON	OFF	OFF	OFF	ON	ON

Cable colour	Assignment
● Red	+12V permanent Pin 18
● Brown	Ground Pin 17
● Orange/Violet	CAN HIGH Pin 6
● Orange/Brown	CAN LOW Pin 12

**No liability for vehicle wire colors and pin definition!
Possible changes by the vehicle manufacturer. The given information must be verified by the installer.**

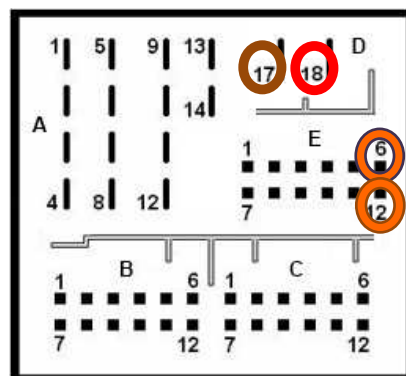

The video-in-motion function is activated permanently without disturbing the navigation performance.

Vehicles with BMW NBT



Place of installation is at the back side of the navigation unit.

Compatible vehicles

BMW 1series (F20/21), 3series (F30/31/32/33)

Navigation

Navigation system **Professional** NBT with 8.8" monitor

Vehicle/ navigation	DIP 1	DIP 2	DIP 3	DIP 4	DIP 5	DIP 6
Professional NBT	ON	OFF	OFF	OFF	ON	ON

Cable colour	Assignment
● ● Brown/Red	+12V permanent 15
● Brown	Ground Pin 12
● Black	CAN HIGH Pin 11
● Yellow	CAN LOW Pin 9

No liability for vehicle wire colors and pin definition!
Possible changes by the vehicle manufacturer. The given information must be verified by the installer.

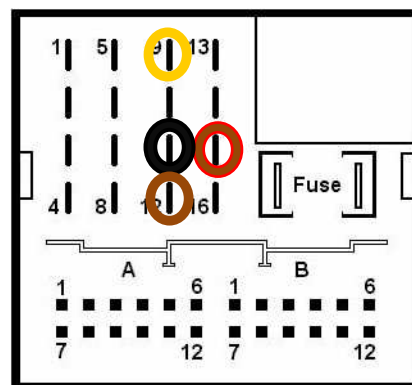

The video-in-motion function is activated permanently without disturbing the navigation performance.

Vehicles with BMW MGU

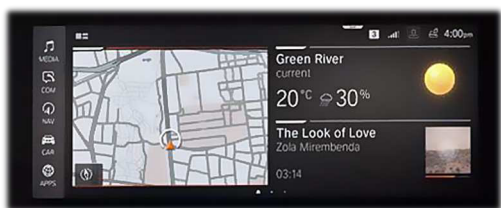

Place of installation is at the back side of the navigation unit.

<i>Compatible vehicles</i>	BMW X5 (G05)
<i>Navigation</i>	Navigation system Professional MGU

Vehicle/ navigation	DIP 1	DIP 2	DIP 3	DIP 4	DIP 5	DIP 6
Professional MGU	ON	OFF	OFF	OFF	OFF	ON

Cable colour	Assignment
● White / ● Orange-green	CAN HIGH Pin 9
● Green	CAN LOW Pin 16



**No liability for vehicle wire colors and pin definition!
Possible changes by the vehicle manufacturer. The given information must be verified by the installer.**

The video-in-motion function is activated permanently without disturbing the navigation performance.

Vehicles with ZAB



Place of installation is at the back side of the navigation unit.

<i>Compatible vehicles</i>	Bentley Continental Coupe GT, VW Phaeton till about 03/2010
<i>Navigation</i>	ZAB

Vehicle/ navigation	DIP 1	DIP 2	DIP 3	DIP 4	DIP 5	DIP 6
All vehicles	ON	OFF	OFF	OFF	OFF	OFF

32-pin connector

Cable colour	Assignment
● Orange/Green	CAN HIGH Pin 16
● Orange/Brown	CAN LOW Pin 32



8-pin power harness

Cable colour	Assignment
● Red	+12V Permanent Pin 7
● Brown	Ground Pin 8

No liability for vehicle wire colors and pin definition! Possible changes by the vehicle manufacturer. The given information must be verified by the installer.

The video-in-motion function is activated permanently without disturbing the navigation performance.

Vehicles with MYGIG



Place of installation is at the back side of the navigation unit.

<i>Compatible vehicles</i>	Chrysler, Dodge and Jeep
<i>Navigation</i>	MYGIG RER/REW/REN/REP/RHW

Vehicle/ navigation	DIP 1	DIP 2	DIP 3	DIP 4	DIP 5	DIP 6
All vehicles	ON	OFF	OFF	OFF	OFF	OFF

Cable colour	Assignment
○ ● White/Orange	CAN-HIGH - Pin 13
○ White	CAN-LOW - Pin 2
● Red	+12V Permanent - Pin 1
● Black/Green	Ground - Pin 12

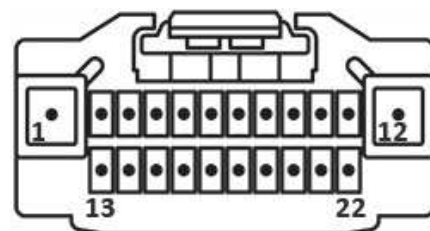

No liability for vehicle wire colors and pin definition! Possible changes by the vehicle manufacturer. The given information must be verified by the installer.

The video-in-motion function is activated permanently without disturbing the navigation performance.

Chrysler, Dodge, Jeep and Fiat Freemount with Uconnect



Place of installation is at the back side of the navigation unit.

<i>Compatible vehicles</i>	Chrysler, Dodge, Jeep, Fiat Freemount
<i>Navigation</i>	Uconnect with 8.4" monitor with 22pin or 52pin connector on rear of head-unit

Vehicle/ navigation	DIP 1	DIP 2	DIP 3	DIP 4	DIP 5	DIP 6
All vehicles	ON	OFF	OFF	OFF	OFF	OFF

Vehicles with 22pin connector on rear of head-unit

Pin No.	Assignment
Pin 7	CAN-HIGH
Pin 18	CAN-LOW
Pin 12	+12V Permanent
Pin 1	Ground

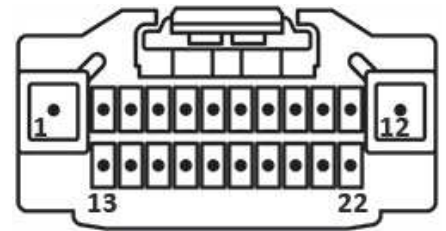

Vehicles with 52pin connector on rear of head-unit

Pin No.	Assignment
Pin 2	CAN-HIGH
Pin 12	CAN-LOW
Pin 44	+12V Permanent
Pin 43	Ground

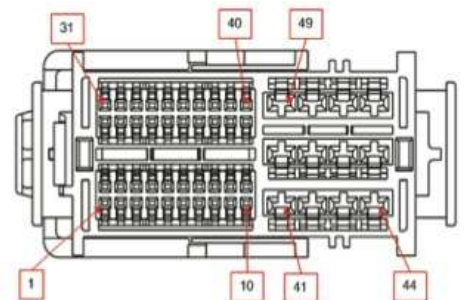

No liability for vehicle wire colors and pin definition! Possible changes by the vehicle manufacturer. The given information must be verified by the installer.

The video-in-motion function is activated permanently without disturbing the navigation performance.

Vehicles with RT3-N3 CAN and RT4



Place of installation is at the back side of the navigation unit.

<i>Compatible vehicles</i>	Citroen, Peugeot
<i>Navigation</i>	RT3-N3 CAN, RT4

Vehicle/ navigation	DIP 1	DIP 2	DIP 3	DIP 4	DIP 5	DIP 6
All vehicles	OFF	OFF	OFF	OFF	OFF	OFF

Cable colour	Assignment
• White	CAN HIGH Pin 10
• Grey	CAN LOW Pin 13

**No liability for vehicle wire colors and pin definition!
Possible changes by the vehicle manufacturer. The given information must be verified by the installer.**

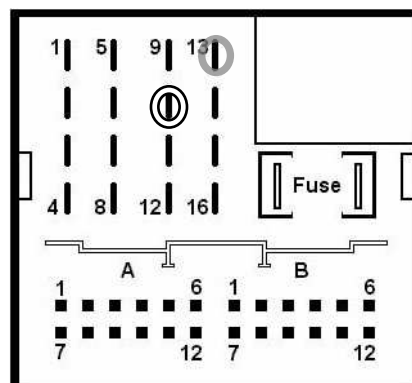

Longpress the "SRC"-button on the steering wheel (about 3 seconds) to activate/deactivate the video-in-motion function. When ignition is off, the video-in-motion interface will be automatically disabled.

Note: While the video-in-motion function is activated, the navigation performance is not possible!

Vehicles with NG4 NaviDrive and NG4 WipCom



Place of installation is at the back side of the navigation unit.

<i>Compatible vehicles</i>	Citroen, Peugeot
<i>Navigation</i>	NG4 NaviDrive (Citroen), NG4 WipCom/WipNav (Peugeot)

Vehicle/ navigation	DIP 1	DIP 2	DIP 3	DIP 4	DIP 5	DIP 6
All vehicles	ON	OFF	OFF	OFF	OFF	OFF

Cable colour	Assignment
• White	CAN HIGH Pin 10
• Grey	CAN LOW Pin 13

**No liability for vehicle wire colors and pin definition!
Possible changes by the vehicle manufacturer. The given information must be verified by the installer.**

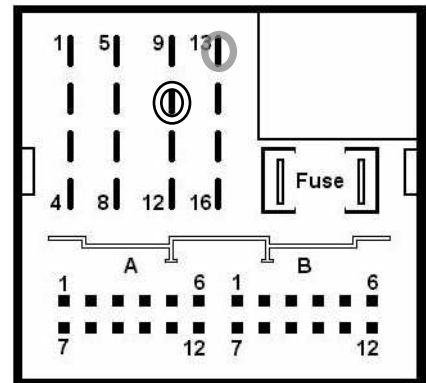

The video-in-motion function is activated permanently without disturbing the navigation performance.

Note: *On some vehicles the navigation performance is affected and as long as the video-in-motion function is activated the navigation will not be working! In this case you have to connect the green cable as described in chapter "Exception: Vehicles with RT3-N3 CAN and RT 4 without Source-button" and set DIP 1 to OFF.*

Ferrari California with MYGIG



Place of installation is at the back side of the navigation unit.

Compatible vehicles Ferrari California

Navigation MYGIG

Vehicle/ navigation	DIP 1	DIP 2	DIP 3	DIP 4	DIP 5	DIP 6
All vehicles	ON	OFF	OFF	OFF	OFF	OFF

Cable colour	Assignment
○ ● White/Orange	CAN-HIGH - Pin 13
○ White	CAN-LOW - Pin 2
● Red	+12V Permanent - Pin 1
● ● Black/Green	Ground - Pin 12

No liability for vehicle wire colors and pin definition! Possible changes by the vehicle manufacturer. The given information must be verified by the installer.

The video-in-motion function is activated permanently without disturbing the navigation performance.

Ford Edge with MYGIG



Place of installation is at the back side of the navigation unit.

Compatible vehicles Ford Edge, Edge 2011

Navigation MYGIG

Vehicle/ navigation	DIP 1	DIP 2	DIP 3	DIP 4	DIP 5	DIP 6
All vehicles	ON	OFF	OFF	OFF	OFF	OFF

Connector A

Cable colour	Assignment
● ● Grau/Orange	CAN-HIGH
● ● Violett/Orange	CAN-LOW

Connector B

Cable colour	Assignment
○ ● White/Red	+12V Permanent
● ● Black/Blue	Ground

**No liability for vehicle wire colors and pin definition!
Possible changes by the vehicle manufacturer. The given information must be verified by the installer.**



Connector A

Connector B

The video-in-motion function is activated permanently without disturbing the navigation performance.

Honda with HondaLink Next Generation Systems



Place of installation is at the back side of the navigation unit.

<i>Compatible vehicles</i>	Civic, Fit (from model 2015)
<i>Navigation</i>	HondaLink Next Generation Systems

Vehicle / navigation	DIP 1	DIP 2	DIP 3	DIP 4	DIP 5	DIP 6
All vehicles	ON	OFF	OFF	OFF	OFF	OFF

20pin connector	Assignment
Pin 13	CAN-HIGH
Pin 3	CAN-LOW

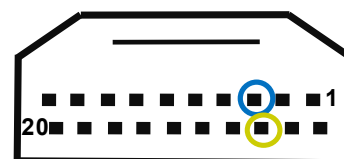

**No liability for vehicle wire colors and pin definition!
Possible changes by the vehicle manufacturer. The given information must be verified by the installer.**

The video-in-motion function is activated permanently without disturbing the navigation performance.

Jaguar XF with Touch-screen navigation version 2



Place of installation is at the back side of the radio module.

<i>Compatible vehicles</i>	Jaguar XF
<i>Navigation</i>	Touch-screen navigation version 2

Vehicle/ navigation	DIP 1	DIP 2	DIP 3	DIP 4	DIP 5	DIP 6
All vehicles	ON	OFF	OFF	OFF	OFF	ON

Cable colour	Assignment
● Yellow/Red	+12V Permanent
● Black	Ground
● Grey/Orange	CAN-HIGH
● Purple/Orange	CAN-LOW

Attention: CAN-LOW and CAN-HIGH could be reversed at older vehicles (e.g. Grey/Orange = CAN-LOW)!

No liability for vehicle wire colors and pin definition!
Possible changes by the vehicle manufacturer. The given information must be verified by the installer.

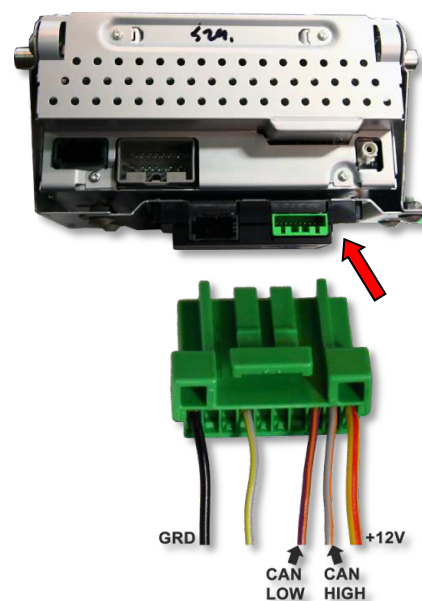

The video-in-motion function is activated permanently without disturbing the navigation performance.

Jaguar XJ and XF with Touch-screen navigation version 3



Place of installation is at the back side of the monitor.

<i>Compatible vehicles</i>	Jaguar XF X250 (from model 2012), XJ X351 (from model 2011)
<i>Navigation</i>	Touch-screen navigation version 3

Vehicle/ navigation	DIP 1	DIP 2	DIP 3	DIP 4	DIP 5	DIP 6
All vehicles	ON	OFF	OFF	OFF	OFF	ON

Cable colour	Assignment
● Grey/Red (Pin 8)	+12V Dauerplus
● Black (Pin 5)	Masse
● Grey/Orange (Pin 2)	CAN-HIGH
● Purple/Orange (Pin 1)	CAN-LOW



**No liability for vehicle wire colors and pin definition!
Possible changes by the vehicle manufacturer. The given information must be verified by the installer.**

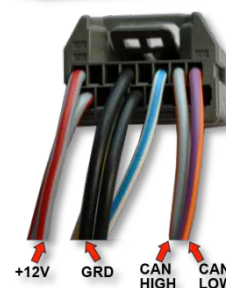

The video-in-motion function is activated permanently without disturbing the navigation performance.

Jaguar with INCONTROL TOUCH PRO



Place of installation is at the back side of the navigation unit (trunk, left side).

Compatible vehicles

Jaguar F-Pace

Navigation

INCONTROL TOUCH PRO (10" monitor)

Vehicle/ navigation	DIP 1	DIP 2	DIP 3	DIP 4	DIP 5	DIP 6
All vehicles	ON	OFF	OFF	OFF	ON	ON

Note: DIP switch functions of the TV-500

DIP 1 – activation TV-free

DIP 2 – no function

DIP 3 – no function

DIP 4 – no function

DIP 5 – CAN-bus termination resistor on the vehicle side

DIP 6 – CAN-bus termination resistor on the head-unit side

Pin-assignment

Cable colour	Assignment
● Purple/Green	CAN-HIGH - Pin17
● Purple/Gray	CAN-LOW - Pin16
● Yellow	+12V Permanent - Pin3
● Black	Ground - Pin1



No liability for vehicle wire colors and pin definition! Possible changes by the vehicle manufacturer. The given information must be verified by the installer.

The video-in-motion function is activated permanently without disturbing the navigation performance.

KIA with 8" navigation



Place of installation is at the back side of the navigation unit.

<i>Compatible vehicles</i>	KIA Sorento (from model 2015)
<i>Navigation</i>	8" navigation

Vehicle/ navigation	DIP 1	DIP 2	DIP 3	DIP 4	DIP 5	DIP 6
All vehicles	ON	OFF	OFF	OFF	OFF	OFF

Note: DIP switch functions of the TV-500

DIP 1 – activation TV-free

DIP 2 – factory rear-view camera existing

DIP 3 – TV icon simulation

DIP 4 – no function

DIP 5 – CAN-bus termination resistor on the vehicle side

DIP 6 – CAN-bus termination resistor on the head-unit side

Connector	Assignment
Connector B, Pin 11/12	+12V permanent
Connector B, Pin 23/24	Ground
Connector B, Pin 1	CAN-HIGH
Connector B, Pin 13	CAN-LOW
Connector B, Pin 16	Speedsignal



Connector A

Connector B

No liability for vehicle wire colors and pin definition! Possible changes by the vehicle manufacturer. The given information must be verified by the installer.

For video in motion cut and isolate additionally the analogue speedsignal wire (pin 16, connector B) (navigation still works over GPS reception).

Optionally, a switch can be installed in the severed speedsignal wire (for the case when GPS reception is bad or not available).

Land Rover with Touch-screen navigation version 1



Place of installation is at the back side of the radio module. (a hide-away box which is located behind the glove box or behind the factory navigation monitor).

Compatible vehicles

Range Rover (Vogue) L322 (2005-2009), Range Rover Sport L320 (2005-2009), Discovery3 L319 (2004-2009)

Navigation

Touch-screen navigation version 1



Vehicle/ navigation	DIP 1	DIP 2	DIP 3	DIP 4	DIP 5	DIP 6
Vehicles without rear-view camera or with after-market rear-view camera	ON	OFF	OFF	OFF	ON	ON
Vehicles with factory rear-view camera	ON	ON	OFF	OFF	ON	ON

Note: DIP switch functions of the TV-500

DIP 1 – activation TV-free

DIP 2 – factory rear-view camera existing

DIP 3 – TV icon simulation

DIP 4 – no function

DIP 5 – CAN-bus termination resistor on the vehicle side

DIP 6 – CAN-bus termination resistor on the head-unit side

Range Rover Vogue

Cable colour	Assignment
●○ Yellow/White	CAN-HIGH Pin 9
●● Yellow/Blue	CAN-LOW Pin 10

Sport & Discovery

Cable colour	Assignment
●○ Yellow/White	CAN-HIGH
● Yellow	CAN-LOW

No liability for vehicle wire colors and pin definition! Possible changes by the vehicle manufacturer. The given information must be verified by the installer.

The video-in-motion function is activated permanently without disturbing the navigation performance.

Land Rover with Touch-screen navigation version 2



Place of installation is at the back side of the radio module. (a hide-away box which is located behind the glove box or behind the factory navigation monitor).

Compatible vehicles

Range Rover (Vogue) L322 (2005-2009), Range Rover Sport L320 (2005-2009), Discovery3 L319 (2004-2009)

Navigation

Touch-screen navigation version 2



Vehicle/ navigation	DIP 1	DIP 2	DIP 3	DIP 4	DIP 5	DIP 6
Vehicles without rear-view camera	ON	OFF	OFF	OFF	ON	ON
Vehicles with rear-view camera	ON	ON	OFF	OFF	ON	ON

Note: DIP switch functions of the TV-500

DIP 1 – activation TV-free

DIP 2 – rear-view camera existing

DIP 3 – TV icon simulation

DIP 4 – no function

DIP 5 – termination resistor CAN-Bus

DIP 6 – termination resistor CAN-Bus

Setting DIP 2 to ON codes the factory rear-view camera input which is located on the brown Fakra male connector of the factory monitor. When reverse gear is engaged, the navigation will automatically switch to this input. On vehicles with factory rear-view camera set DIP 2 to ON, too.

Range Rover Vogue

Cable colour	Assignment
●○ Yellow/White	CAN-HIGH Pin 9
●● Yellow/Blue	CAN-LOW Pin 10

Sport & Discovery

Cable colour	Assignment
●○ Yellow/White	CAN-HIGH
● Yellow	CAN-LOW

No liability for vehicle wire colors and pin definition! Possible changes by the vehicle manufacturer. The given information must be verified by the installer.

The video-in-motion function is activated permanently without disturbing the navigation performance.

Land Rover from 2012 with Touch-screen navigation version 3



Place of installation is at the back side of the monitor.

Compatible vehicles

Range Rover Evoque L538, Range Rover Sport, Discovery4
from year 2012

Navigation

Touch-Screen Navigation 3rd generation



Vehicle/ navigation	DIP 1	DIP 2	DIP 3	DIP 4	DIP 5	DIP 6
Vehicles without rear-view camera	ON	OFF	OFF	OFF	ON	ON
Vehicles with rear-view camera	ON	ON	OFF	OFF	ON	ON

Note: DIP switch functions of the TV-500

DIP 1 – activation TV-free

DIP 2 – rear-view camera existing

DIP 3 – TV icon simulation

DIP 4 – no function

DIP 5 – CAN-bus termination resistor on the vehicle side

DIP 6 – CAN-bus termination resistor on the head-unit side

Setting DIP 2 to ON codes the factory rear-view camera input which is located on the brown Fakra male connector of the factory monitor. When reverse gear is engaged, the navigation will automatically switch to this input. On vehicles with factory rear-view camera set DIP 2 to ON, too.

Pin-assignment factory monitor connector

Cable colour	Assignment
● Orange/grey	CAN-HIGH Pin 2
● Orange/purple	CAN-LOW Pin 1

No liability for vehicle wire colors and pin definition! Possible changes by the vehicle manufacturer. The given information must be verified by the installer.

The video-in-motion function is activated permanently without disturbing the navigation performance.

Land Rover from 2015 with Touch-screen navigation version 4

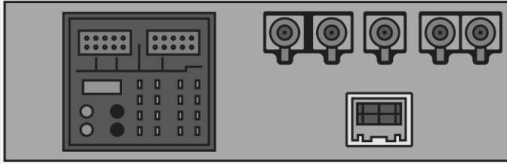

Place of installation is at the back side of the navigation unit.

Compatible vehicles

Land Rover vehicles **from year 2015**

Navigation

Touch-Screen Navigation 4th generation (8" monitor)



Version I



Version II



Version III

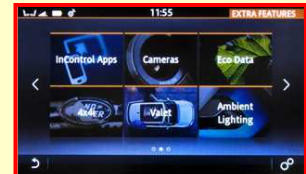

Version IV

Vehicle/ navigation	DIP 1	DIP 2	DIP 3	DIP 4	DIP 5	DIP 6
Vehicles without rear-view camera	ON	OFF	OFF	OFF	ON	ON
Vehicles with rear-view camera	ON	ON	OFF	OFF	ON	ON

Note: DIP switch functions of the TV-500

DIP 1 – activation TV-free

DIP 2 – rear-view camera existing

DIP 3 – TV icon simulation

DIP 4 – no function

DIP 5 – CAN-bus termination resistor on the vehicle side

DIP 6 – CAN-bus termination resistor on the head-unit side

Setting DIP 2 to ON codes the factory rear-view camera input which is located on the brown Fakra male connector of the factory monitor. When reverse gear is engaged, the navigation will automatically switch to this input. On vehicles with factory rear-view camera set DIP 2 to ON, too.

Pin-assignment Quadlock connector

Function	Pin-No.
CAN-HIGH	Pin 3 (chamber B)
CAN-LOW	Pin 9 (chamber B)
+12V permanent	Pin 13
Ground	Pin 11

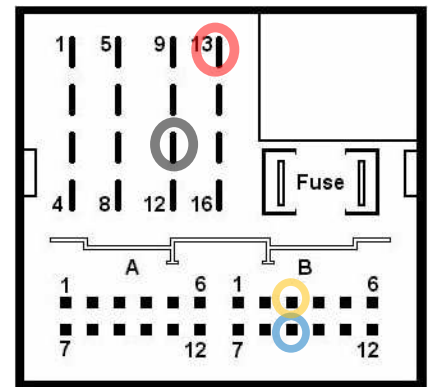

No liability for vehicle wire colors and pin definition! Possible changes by the vehicle manufacturer. The given information must be verified by the installer.

The video-in-motion function is activated permanently without disturbing the navigation performance.

Land Rover with INCONTROL TOUCH PRO



Place of installation is at the back side of the navigation unit (below passenger seat).

Compatible vehicles Range Rover Evoque, Sport **from year 2016**
Navigation INCONTROL TOUCH PRO (10" monitor)

Vehicle/ navigation	DIP 1	DIP 2	DIP 3	DIP 4	DIP 5	DIP 6
All vehicles	ON	OFF	OFF	OFF	ON	ON

Note: DIP switch functions of the TV-500

DIP 1 – activation TV-free

DIP 2 – no function

DIP 3 – no function

DIP 4 – no function

DIP 5 – CAN-bus termination resistor on the vehicle side

DIP 6 – CAN-bus termination resistor on the head-unit side

Pin-assignment

Cable colour	Assignment
● Purple/Green	CAN-HIGH - Pin17
● Purple/Gray	CAN-LOW - Pin16
● Yellow	+12V Permanent - Pin3
● Black	Ground - Pin1

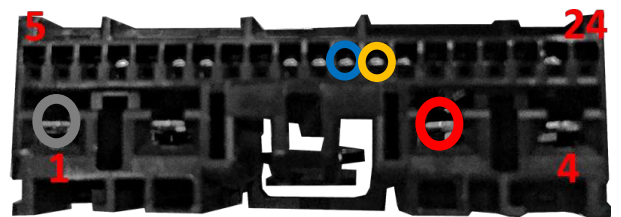

No liability for vehicle wire colors and pin definition! Possible changes by the vehicle manufacturer. The given information must be verified by the installer.

The video-in-motion function is activated permanently without disturbing the navigation performance.

Mercedes Benz with Comand 2.0



Place of installation is at the back side of the navigation unit.

Compatible vehicles

Mercedes Benz C-class (W203) til 03/2004, CLK-class (C208 W208) all years, CLK-class (C209 W209) til 05/2004, E-class (W210) all years, G-Model (G463) from 12/2000 til 03/2007, ML-class (W163) all years, SL-class (R230) til 06/2004, CL-class (C215) til 09/2003, S-class (W220) til 09/2003

Navigation

Comand 2.0, Comand APS220/CD

Vehicle/ navigation	DIP 1	DIP 2	DIP 3	DIP 4	DIP 5	DIP 6
All vehicles	ON	OFF	OFF	OFF	OFF	OFF

Cable colour	Assignment
● Red	+12V Permanent A Pin 4
● Black	Ground A Pin 8
●● Brown/Red	CAN-HIGH C2 Pin 9
● Brown	CAN-LOW C2 Pin 8

**No liability for vehicle wire colors and pin definition!
Possible changes by the vehicle manufacturer. The given information must be verified by the installer**

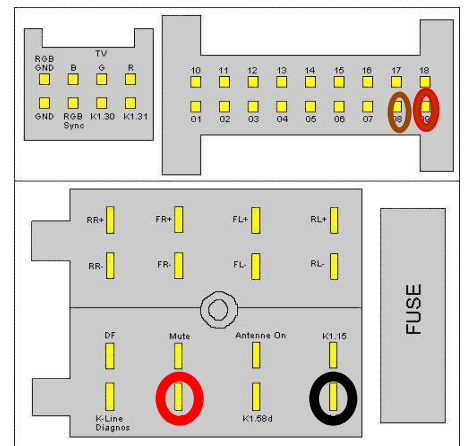

The video-in-motion function is activated permanently without disturbing the navigation performance.

Mercedes Benz with Comand 2.5



Place of installation is at the back side of the navigation unit.

<i>Compatible vehicles</i>	Mercedes Benz CL-class (C215) til 09/2003, S-class (W220) til 09/2003
<i>Navigation</i>	Comand 2.5

Vehicle/ navigation	DIP 1	DIP 2	DIP 3	DIP 4	DIP 5	DIP 6
All vehicles	ON	OFF	OFF	OFF	OFF	OFF

Cable colour	Assignment
● Red	+12V Permanent A Pin 4
● Black	Ground A Pin 8
●● Brown/Red	CAN-HIGH C2 Pin 18
● Brown	CAN-LOW C2 Pin 17

**No liability for vehicle wire colors and pin definition!
Possible changes by the vehicle manufacturer. The given information must be verified by the installer**

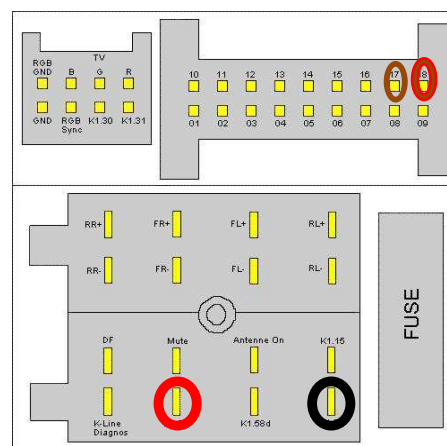

The video-in-motion function is activated permanently without disturbing the navigation performance.

Maybach and Mercedes Benz with Comand APS NTG 1



Place of installation is at the AGW-module (Audio-Gate-Way). The AGW-module is placed in the luggage compartment at the left hand side behind the cover of the navigation unit or under the driver seat (SLK R171) or under the front passenger seat (SL R230).

Compatible vehicles

Maybach (with green Fakra connector on backside of Comand), Mercedes Benz CL-class (C215) from 10/2003 til 12/2005, S-class (W220) from 10/2003 til 09/2005, SL-class (R230) from 07/2004 til 03/2008, CLS-Coupe (W219) from 10/2004 til 03/2008, E-class (W211) til 05/2008, SLK-class (R171) from 03/2004 til 03/2008

Navigation

Comand APS DVD, Comand APS NTG1

Vehicle/ navigation	DIP 1	DIP 2	DIP 3	DIP 4	DIP 5	DIP 6
All vehicles	ON	OFF	OFF	OFF	OFF	OFF

Cable colour	Assignment
●● Brown/Red	CAN-HIGH Pin 2
● Brown	CAN-LOW Pin 4

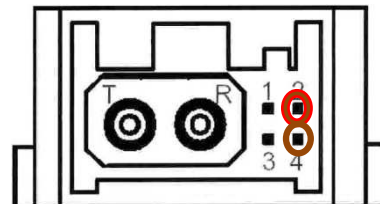

**No liability for vehicle wire colors and pin definition!
Possible changes by the vehicle manufacturer. The given information must be verified by the installer.**

The video-in-motion function is activated permanently without disturbing the navigation performance.

Mercedes Benz with Comand APS NTG 2/NTG 2.5/NTG 4 and Comand Online, NTG 4.5 VW Crafter with Comand APS NTG2



Place of installation is at the back side of the navigation unit.

Compatible vehicles

Mercedes Benz A-class (W169) from 09/2004 til 06/2008, B-class (W245) from 09/2004 til 06/2008, C-class (W203) from 04/2004 til 02/2007, CLC-class (CL203) from 06/2008 til 09/2008, CLK-class (C209 W209) from 06/2004, G-model (G463) from 04/2007 til 08/2008, GL-class (X164) til 06/2008, ML-class (W164) til 06/2008, R-class (W251) til 06/2008, Sprinter, Viano, A-class (W169) from 07/2008, B-class (W245) from 07/2008 til 10/2011, CLS-Coupe (W219) from 04/2008 til 12/2010, E-class (W211) from 06/2008 til 03/2009, G-model (G463) from 09/2008, GL-class (X164) from 07/2008, ML-class (W164) from 07/2008 til 10/2011, R-class (W251) from 07/2008, SL-class (R230) from 04/2008, SLK-class (R171) from 04/2008 til 02/2011, Viano, C-class (W204) from 03/2007 til 02/2011, CLC-class (CL203) from 09/2008, GLK-class (X204) from 09/2008, SLS (C197) from 03/2010, E-class (W212) from 04/2009 til 05/2011, E-class Coupe (W207) from 05/2009 til 05/2011, CLS-Coupe (C218) from 01/2011 til 05/2011, B-class (W246) from 11/2011, C-class (W204) from 03/2011, C-class Coupe (C204) from 06/2011, E-class (W212) from 06/2011, E-class Coupe (C207) from 06/2011, CLS-Coupe (C218) from 06/2011, GLK-class (W204) from 01/2011, ML-class (W166) from 11/2011, SLK-class (R172) from 03/2011, SL-class (R231) from 2012, VW Crafter

Navigation

Comand APS NTG2/NTG2.5/NTG4-204/NTG4-212,
Comand Online NTG 4.5

Vehicle/ navigation	DIP 1	DIP 2	DIP 3	DIP 4	DIP 5	DIP 6
Vehicles with NTG2/NTG4-xxx	ON	OFF	OFF	OFF	OFF	OFF
Vehicles with NTG2.5/NTG4.5	OFF	OFF	OFF	OFF	OFF	OFF

Cable colour	Assignment
● Red/Blue	+12Volt Permanent 15
● Brown	Ground Pin 12
● Brown/Red	CAN HIGH Pin 11
● Brown	CAN LOW Pin 9

**No liability for vehicle wire colors and pin definition!
Possible changes by the vehicle manufacturer. The given
information must be verified by the installer.**

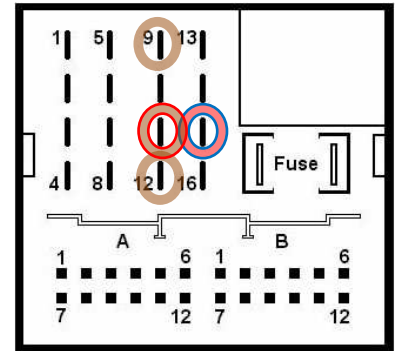

On vehicles with **NTG2/NTG4-2xx** the video-in-motion function is activated permanently without disturbing the navigation performance.

On vehicles with **NTG2.5/NTG4.5** select the “navigation level” on the instrument and press the “hang-up”-button on the steering-wheel for more than 3 seconds to activate/deactivate the video-in-motion function. When the ignition is off, the video-in-motion interface will be automatically disabled.



Note: *As long as the video-in-motion function is activated, the navigation of the command **will NOT be working!***

Vehicles with Mercedes Benz Comand NTG 3 and NTG 3.5



Place of installation is in the centre console behind the DVD unit.

Compatible vehicles

Mercedes Benz CL-class (C216) from 01/2006 til 05/2009, S-class (W221) from 10/2005 til 05/2009, S-class (W221) from 06/2009, CL-class (C216) from 06/2009 with Dual-View

Navigation

Comand APS NTG 3 and NTG 3.5

Vehicle/ navigation	DIP 1	DIP 2	DIP 3	DIP 4	DIP 5	DIP 6
All vehicles	ON	OFF	OFF	OFF	ON	ON

Cable colour	Assignment
●o Yellow/White	CAN-HIGH Pin 1
● Yellow	CAN-LOW Pin 11

No liability for vehicle wire colors and pin definition! Possible changes by the vehicle manufacturer. The given information must be verified by the installer.

The video-in-motion function is activated permanently without disturbing the navigation performance.

Vehicles with Mercedes Benz Comand NTG 5 / NTG5.1



Place of installation is at the back side of the navigation unit.

Requirements

<i>Vehicle</i>	Mercedes Benz C-class (W205), S-class (W222), V-class (W477) and more types.
<i>Navigation</i>	Comand NTG 5, Comand NTG5.1

Vehicle/ navigation	DIP 1	DIP 2	DIP 3	DIP 4	DIP 5	DIP 6
Video-in-motion permanent	ON	OFF	OFF	OFF	OFF	ON
Video-in-motion selective*	OFF	OFF	OFF	OFF	OFF	ON

Pin-assignment vehicle connector

Cable colour	Assignment
● Red	+12Volt Permanent 15
● Brown	Ground Pin 12
● Yellow/White ; ● Brown/Red ; ● Purple/White	CAN HIGH Chamber B -Pin 9
● Yellow ; ● Brown ; ● Purple	CAN LOW Chamber B - Pin 3

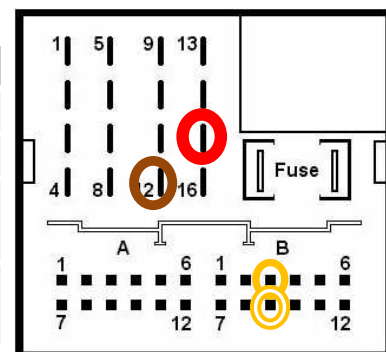

No liability for vehicle wire colors and pin definition! Possible changes by the vehicle manufacturer. The given information must be verified by the installer.

The video-in-motion function is activated permanently without disturbing the navigation performance.

Vehicles with Mercedes Benz MBUX NTG 6



Place of installation is at the back side of the navigation unit.

A-class: On the A-pillar on the driver's side

GLE, GLS: Below passenger seat

Sprinter: Behind the factory monitor

Requirements

Vehicle Mercedes Benz A-class (W177), Sprinter (W907), GLE (C167), GLS (X167) und more types.

Navigation MBUX NTG 6

Limitations

MBUX Augmented Reality While the video-in-motion function is active, it is not possible to use the camera traffic light display function!

Vehicle/ navigation	DIP 1	DIP 2	DIP 3	DIP 4	DIP 5	DIP 6
Video-in-motion permanent	ON	OFF	OFF	OFF	OFF	ON
Video-in-motion selective*	OFF	OFF	OFF	OFF	OFF	ON

Video-in-motion selective via hang up button

With DIP 1 set to OFF, a long press (3 sec.) on the steering wheel "hang up" button is used to activate / deactivate the video-in-motion function.

(After ACC is switched off, the video-in-motion function will be automatically deactivated)



Pin-assignment vehicle connector – 26pin version

Cable colour	Assignment
● Red	+12Volt Permanent - Pin14
● Brown	Ground - Pin 1
● Purple/White	CAN HIGH - Pin 7
● Purple	CAN LOW - Pin 20

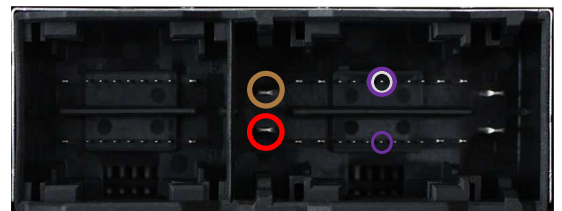

No liability for vehicle wire colors and pin definition! Possible changes by the vehicle manufacturer. The given information must be verified by the installer.

The video-in-motion function is activated permanently without disturbing the navigation performance.

Porsche with PCM 2.1



Place of installation is at the back side of the navigation unit.

<i>Compatible vehicles</i>	Porsche Cayenne E1
<i>Navigation</i>	PCM 2.1

Vehicle/ navigation	DIP 1	DIP 2	DIP 3	DIP 4	DIP 5	DIP 6
All vehicles	ON	OFF	OFF	OFF	OFF	OFF

Cable colour	Assignment
● Red	+12V Dauerstrom Pin 4
● Black	Ground Pin 8
● Orange/Purple	CAN HIGH Pin 1 (Kammer C1)
● Orange/Brown	CAN LOW Pin 2 (Kammer C1)

**No liability for vehicle wire colors and pin definition!
Possible changes by the vehicle manufacturer. The given information must be verified by the installer.**

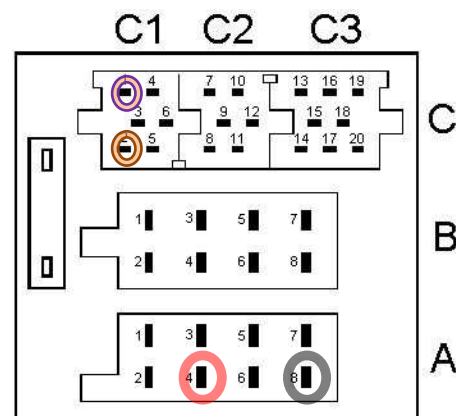

The video-in-motion function is activated permanently without disturbing the navigation performance.

Porsche with PCM 3.0 and PCM 3.1



Place of installation is at the back side of the navigation unit.

Compatible vehicles Cayenne E1, 911, Boxster, Cayman, Cayenne E2, Panamera

Navigation PCM 3.0 and 3.1

Limitations

Internal DVD video cannot be watched!

Vehicle/ navigation	DIP 1	DIP 2	DIP 3	DIP 4	DIP 5	DIP 6
Vehicles without rear-view camera or with after-market rear-view camera	ON	OFF	OFF	OFF	ON	ON
Vehicles with factory rear-view camera	ON	ON	OFF	OFF	ON	ON

Cable colour	Assignment
● Red	+12V Permanent Pin 15
● Black	Ground Pin 12
● Orange/Purple	CAN HIGH Pin 11
● Orange/Brown	CAN LOW Pin 9

No liability for vehicle wire colors and pin definition!
Possible changes by the vehicle manufacturer. The given information must be verified by the installer.

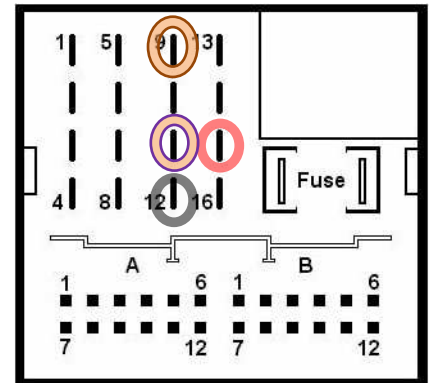

The video-in-motion function is activated permanently without disturbing the navigation performance.

Porsche with PCM4



Place of installation is at the back side of the navigation unit

<i>Compatible vehicles</i>	911
<i>Navigation</i>	PCM4

Vehicle/navigation	DIP 1	DIP 2	DIP 3	DIP 4	DIP 5	DIP 6
PCM4	ON	OFF	OFF	OFF	OFF	OFF

Cable colour	Assignment
● Red	+12V permanent Pin 18
● Black	Ground Pin 17
● Orange/Purple	CAN HIGH Pin 6
● Orange/Brown	CAN LOW Pin 12

**No liability for vehicle wire colors and pin definition!
Possible changes by the vehicle manufacturer. The given information must be verified by the installer.**

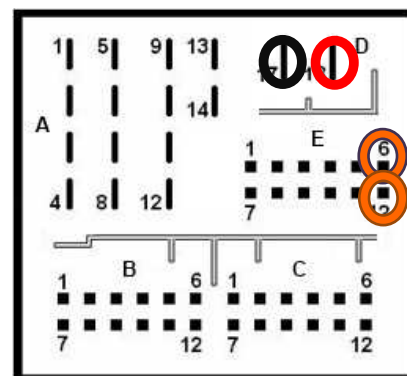

The video-in-motion function is activated permanently without disturbing the navigation performance.

Renault / Smart



Place of installation is at the back side of the monitor.

Compatible vehicles Captur, Megane III, ZOE, Fortwo, Forfour
Navigation R-Link 1, Smart Media-System (7")

Vehicle/navigation	DIP 1	DIP 2	DIP 3	DIP 4	DIP 5	DIP 6
R-Link	ON	OFF	OFF	OFF	ON	ON

Cable colour	Assignment
● Purple / ● Grey-white	CAN HIGH Pin 12
● White / ● Brown-white	CAN LOW Pin 11



No liability for vehicle wire colors and pin definition!
Possible changes by the vehicle manufacturer. The given information must be verified by the installer.

The video-in-motion function is activated permanently without disturbing the navigation performance.

Volvo with RTI 2011



Place of installation is at the back side of the monitor.

Compatible vehicles Volvo S-series, V-series, XC60

Navigation RTI 2011

Limitations

Vehicles with lane pilot, distance assistant and city safety system The included green cable is used to activate the video-in-motion function (+12V = activated).

Lane pilot, distance assistant and city safety system do **not** work while TV-free is activated!

Fahrzeug/ Navigation	DIP 1	DIP 2	DIP 3	DIP 4	DIP 5	DIP 6
Vehicles WITHOUT extra equipment (lane pilot, distance assistant, city safety system)	ON	OFF	OFF	OFF	ON	ON
Vehicles WITH extra equipment (lane pilot, distance assistant, city safety system)	OFF	OFF	OFF	OFF	ON	ON

Cable colour	Assignment
●● Purple/Red	+12V Permanent
●● Black/Grey	Ground
●● Grey/Orange	CAN HIGH Pin 10
●● Purple/Orange	CAN LOW Pin 09

No liability for vehicle wire colors and pin definition!
Possible changes by the vehicle manufacturer. The given information must be verified by the installer.

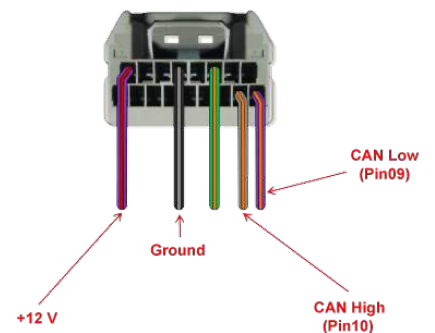

On **vehicles without extra equipment** and DIP1 to ON the video-in-motion function is activated permanently without disturbing the navigation performance.

On **vehicles with extra equipment** and DIP1 to OFF the included green cable is used to activate the video-in-motion function.

Connect a switch to the green cable and connect the green cable to +12V ACC.

- +12V = TV-Free is activated
- 0V = TV-Free is not activated

Note: *As long as the video-in-motion function is activated, the navigation will NOT be working!*

Vehicles with VW MFD2/RNS2 und Skoda Nexus



Place of installation is at the back side of the navigation unit.

Compatible vehicles VW Touareg; Golf 5, Touran, T5, Passat from year 2006, Caddy Live, Skoda Octavia 2 and other vehicles

Navigation VW MFD2/RNS2, Skoda Nexus

Vehicle/ navigation	DIP 1	DIP 2	DIP 3	DIP 4	DIP 5	DIP 6
All vehicles	ON	OFF	OFF	OFF	OFF	OFF

Cable colour	Assignment
● Red/Yellow	+12V Permanent Pin 15
● Brown	Ground Pin 12
● Orange/Green	CAN HIGH Pin 9
● Orange/Brau	CAN LOW Pin 10

No liability for vehicle wire colors and pin definition!
Possible changes by the vehicle manufacturer. The given information must be verified by the installer.

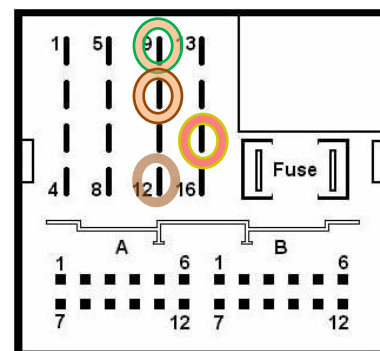

The video-in-motion function is activated permanently without disturbing the navigation performance.

Vehicles with VW RNS510/810, Skoda Columbus and Seat Trinx



Place of installation is at the back side of the navigation unit.

<i>Compatible vehicles</i>	VW Touareg, T5, Touran, Golf 6 and other vehicles
<i>Navigation</i>	VW RNS510 and 810, Skoda Columbus, Seat Trinx

Vehicle/ navigation	DIP 1	DIP 2	DIP 3	DIP 4	DIP 5	DIP 6
All vehicles	ON	OFF	OFF	OFF	OFF	OFF

Cable colour	Assignment
● Red/Yellow	+12V Permanent Pin 15
● Brown	Ground Pin 12
● Orange/Green	CAN HIGH Pin 9
● Orange/Brau	CAN LOW Pin 10

**No liability for vehicle wire colors and pin definition!
Possible changes by the vehicle manufacturer. The given information must be verified by the installer.**

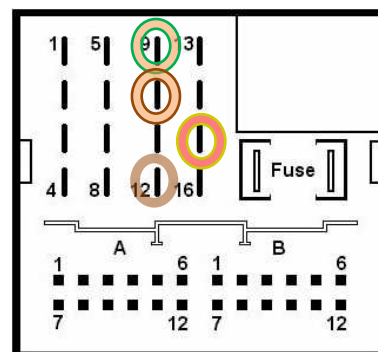

The video-in-motion function is activated permanently without disturbing the navigation performance.

Vehicles with VW, Skoda MIB High



Place of installation is at the back side of the navigation unit

<i>Compatible vehicles</i>	Golf 7, Octavia 3
<i>Navigation</i>	MIB High – Discover Pro, Columbus

Vehicle/navigation	DIP 1	DIP 2	DIP 3	DIP 4	DIP 5	DIP 6
MIB High	ON	OFF	OFF	OFF	ON	ON

Cable colour	Assignment
● Red	+12V permanent Pin 18
● Brown	Ground Pin 17
● Orange/Violet	CAN HIGH Pin 6
● Orange/Brown	CAN LOW Pin 12

**No liability for vehicle wire colors and pin definition!
Possible changes by the vehicle manufacturer. The given information must be verified by the installer.**

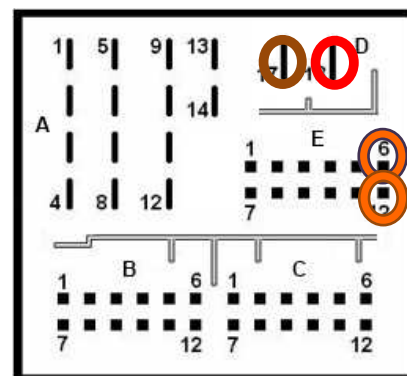

The video-in-motion function is activated permanently without disturbing the navigation performance.

3. Specifications

Operation voltage	10.5 – 14.8V
Stand-by power drain	<2mA
Operation power drain	~60mA
Power consumption	~0,08W
Temperature range	-30°C to +80°C
Weight	44g
Measurements (box only) W x H x D	76 x 27 x 54 mm

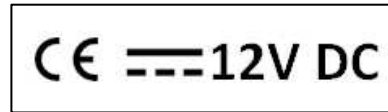

4. Technical support

CAS GmbH
manufacturer/distribution
In den Fuchslöchern 3
D-67240 Bobenheim-Roxheim

email support@casgermany.com

Legal disclaimer: Mentioned company and trademarks, as well as product names/codes are registered trademarks ® of their corresponding legal owners.